

GA
N200.G4
S1
P7
no.41

AQUIFER PERFORMANCE TEST REPORT

Miocene Aquifer, Evans County, Georgia

December 9 - December 31, 1998

By

Rex A. Hodges

**Department of Natural Resources
Environmental Protection Division
Georgia Geologic Survey**

**Atlanta
1999**

Project Report 41

AQUIFER PERFORMANCE TEST REPORT

Miocene Aquifer, Evans County, Georgia

December 9 - December 31, 1998

By

**Rex A. Hodges
Department of Geological Sciences
Clemson University**

This report has not been reviewed for conformity with Georgia Geologic Survey editorial standards, stratigraphic nomenclature, and standards of professional practice.

**Department of Natural Resources
Lonice C. Barrett, Commissioner
Environmental Protection Division
Harold F. Reheis, Director
Georgia Geologic Survey
William H. McLemore, State Geologist**

**Atlanta
1999**

Project Report 41

Table of Contents

	<u>page</u>
ABSTRACT	1
INTRODUCTION	2
Purpose of the Evans County Miocene Aquifer Performance Test	2
Site Conditions.....	2
Location.....	2
Hydrogeologic Setting.....	4
Description of Wells Used for the Test.....	5
METHODS	9
Test Logistics	9
Data Acquisition Methods	10
Analysis Methods.....	11
Trend Effect Corrections.....	11
Leakage.....	11
Well Analysis Methods	11
RESULTS	13
Water Level Readings.....	13
Calculated Aquifer Properties.....	15
Specific Capacity.....	16
Leakage	17
DISCUSSION	19
Test Logistics	19
Analysis	19
REFERENCES	22

List of Figures

	<u>page</u>
Figure 1. Map of Georgia showing the location of the Evans County test site.	3
Figure 2. Map showing the Evans County test site, about 5 miles N of Claxton.	4
Figure 3. Gamma ray and resistivity log from Evans County	6
Figure 4. Schematic well construction diagram for Evans County #1.....	7
Figure 5. Schematic well construction diagram for Evans County #2.....	7
Figure 6. Schematic well construction diagram for Evans County #3.....	8
Figure 7. Schematic well construction diagram for Evans County #4.....	8
Figure 8. Flow rate plotted as a function of time for the Evans County #1 test.....	10
Figure 9. Graph of water level data in the PW, Evans #1, December 9 through December 31.....	13
Figure 10. Time / drawdown curve from Evans County	14
Figure 11. Theis-Jacob curve match for Evans County #1, T of 25 ft ² /day. ...	16
Figure 12. Schematic section of the Evans County well cluster.	17
Figure 13. Water depth vs time for Evans County #3.....	18
Figure 14. Water depth vs time for Evans County #4.....	18

ABSTRACT

As part of the Geologic Survey Branch of the Georgia Environmental Protection Division's "Evaluation of the Miocene Aquifers in the Coastal Area of Georgia Project", the Department of Geological Sciences at Clemson University conducted a pump test at the Georgia Geologic Survey's Evans County well cluster, located on Beasley Farm, Evans County, Georgia. A test of the Lower Brunswick was conducted from December 9 through December 31, 1998, pumping Evans County #1. The test, single well with no observation well in the pumped zone, had an average flowrate of five gpm. Calculations indicate a transmissivity (T) of about 25 ft²/day (19 - 28 ft²/day depending on the curve match). The water bearing zone was assumed to be fully screened, with the screen zone ranging from 265 ft to 325 ft. There are three additional wells at the site, though none are screened in the Lower Brunswick. An aquifer thickness of 60 ft, based on the screen length, gives a hydraulic conductivity of 0.28 ft/day and a permeability of 100 millidarcys. The well was monitored for one week prior to pumping with no discernable water level trend.

INTRODUCTION

Purpose of the Evans County

Miocene Aquifer

Performance Test

Due to the hydrologic stress imposed on the Eocene to Oligocene age Upper Floridan Aquifer, the principal water source of coastal Georgia, the Geologic Survey Branch of the Georgia Environmental Protection Division is investigating the Miocene aquifers as an additional source of ground water for the region. The test at Evans County is the fourth of seven Miocene aquifer tests (Tybee Island, St. Marys, and Toombs County were done previously) to be conducted at selected sites in southeast Georgia. Four of the seven test sites will be located in coastal counties, and three of the sites will be located inland where agricultural ground-water use is prevalent. The purpose of the Evans County test is to estimate the transmissivity of the Miocene aquifer. The results from each of the seven sites will be utilized in combination with other geologic data to determine if the Miocene aquifers are viable alternatives to the Upper Floridan aquifer for smaller-demand needs such as community water supply, golf courses, agricultural (lower demand or supplemental), small industries, and non-contact cooling water.

Site Conditions

Location

The Evans County site is located about twenty-five miles south of Statesboro, Georgia. The nearest town is Claxton, about five miles south of the site. Figure 1 is a map of Georgia showing the location of the Evans County test site, Toombs County test site, St. Marys test site, and the Tybee Island test site.

Miocene Aquifer Study Location Map

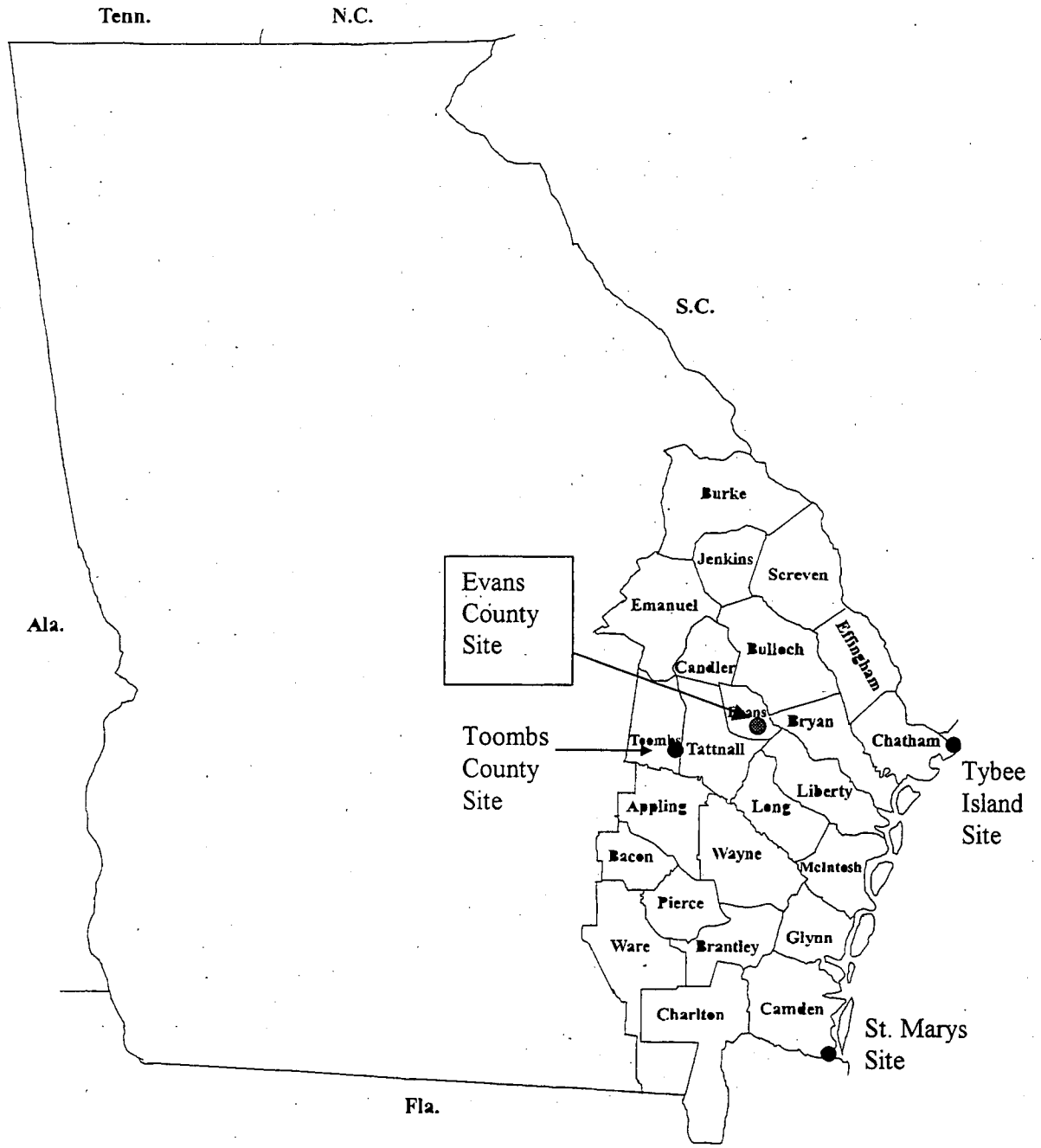
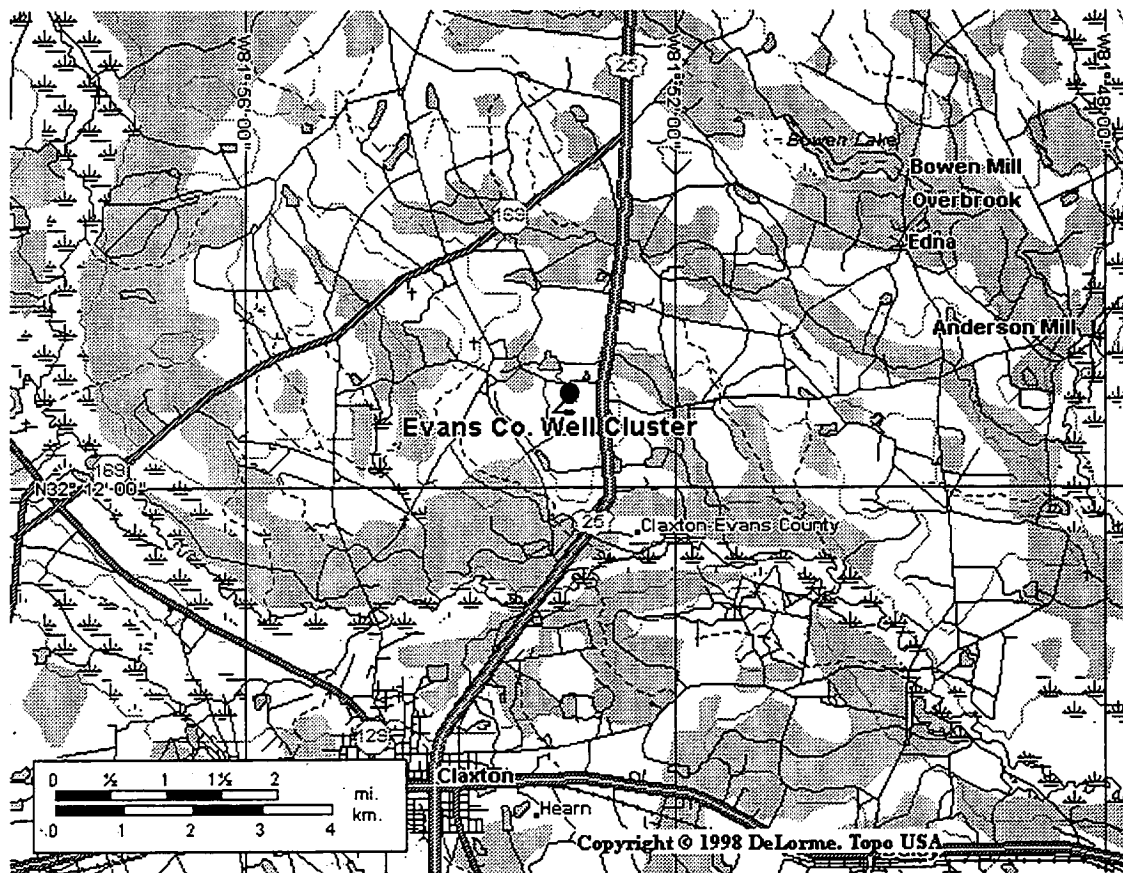

Figure 1. Map of Georgia showing the location of the Evans County test site.

Figure 2. Map showing the Evans County test site, about five miles N of Claxton. The well cluster is located about five miles north of Claxton on Beasley Farm.



Hydrogeologic Setting

The lithologic units underlying the site dip and thicken to the southeast. The Evans County well cluster is drilled into Coastal Plain sediments ranging in age from Eocene to Miocene. The hydrostratigraphy penetrated at the site consists principally of four zones, the unconfined surficial aquifer, a confined zone equivalent to the Upper Brunswick Miocene, a confined zone equivalent to the Lower Brunswick Miocene (tested), and the Upper Floridan. The zones equivalent to the Brunswick aquifers produce

limited yields and are not economically viable water sources in the classical sense of the term aquifer. The geophysical well logs are shown in Figure 3.

The Lower Brunswick at the site, as defined by the screen zone, is 60 ft of sands with interbedded clays. The zone is confined with a pressure head of 165 ft above the screen top (265 ft deep).

Description of Wells Used for the Test

At the Evans County test site four wells were drilled. Evans County #1 (PW, pumping well) was drilled and completed in the Lower Brunswick, Evans County #2 was completed in the Upper Floridan, Evans County #3 was completed in the Upper Brunswick, and Evans County #4 was completed in the surficial aquifer. Schematic well construction diagrams are shown in Figures 4, 5, 6, 7.

Site coordinates:31°13'07" lat. 81°52'59" long.
 Year of construction:1998
 Ground elevation:140 ft MSL (estimated from topographic map)

Evans #1
 Screen zone265 – 325 ft
 Total Depth330 ft

Evans #2
 Open hole450 – 500 ft
 Total Depth500 ft

Evans #3
 Screen zone185 – 220 ft
 Total Depth230 ft

Evans #4
 Screen zone45 – 80 ft
 Total Depth90 ft

Figure 3. Gamma ray and resistivity log from Evans County #2. The gamma ray scale is at the top and the resistivity scale is at the bottom of the diagram. The screen zone is shown from 265 – 325 ft.

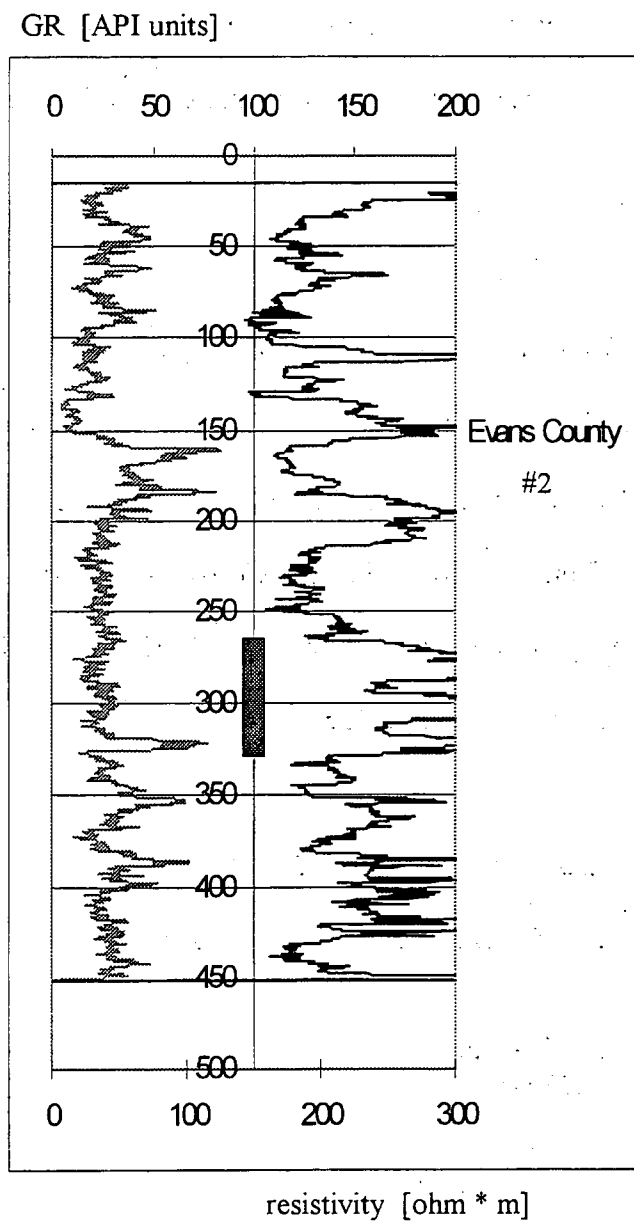

Figure 4. Schematic well construction diagram for Evans County #1.

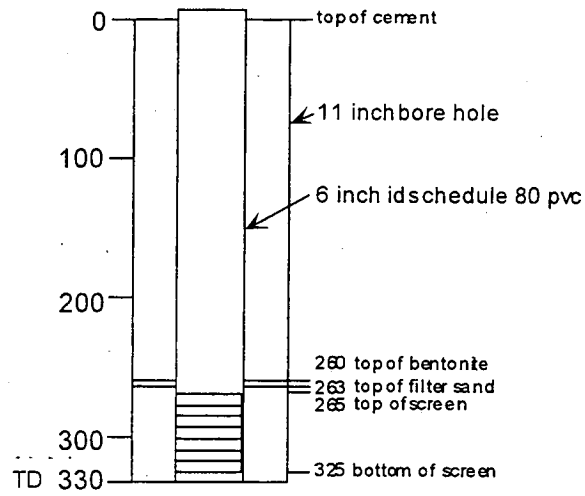

Figure 5. Schematic well construction diagram for Evans County #2.

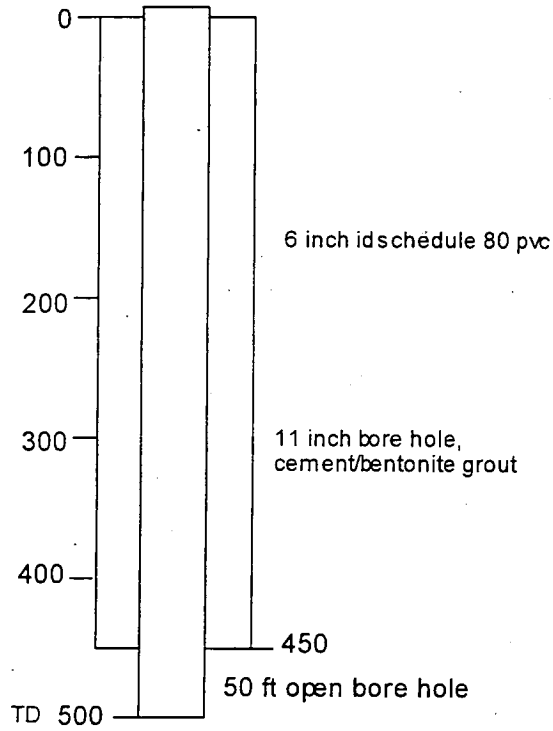

Figure 6. Schematic well construction diagram for Evans County #3.

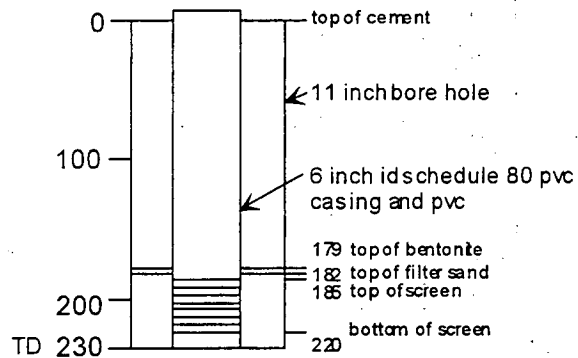
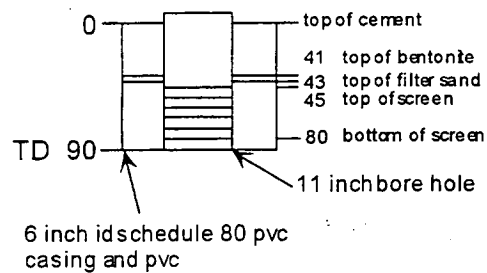

Figure 7. Schematic well construction diagram for Evans County #4.



METHODS

Test Logistics

The test took place from December 9 to December 31, 1998. The Lower Brunswick was pumped from Evans County #1. A one hp pump was installed at 178 ft, 78 ft below water (the static water level was 100 ft), on December 9 and a short thirty minute trial pump test was conducted to determine optimum flow rate (Q) for the actual test. The well was expected to yield 10 – 15 gallons per minute. An initial Q of 16 - 18 gpm pumped the well dry in about ten minutes. Back pressure was increased by partially closing the flow valve opening to decrease the flow rate. The well was able to sustain a rate of 3 – 4 gpm. The pump was shut off and background data was collected over the next week. On December 16, the 1 hp pump was removed and replaced by a ½ hp pump that was set at 220 ft, 45 ft above the screen. A short test indicated the well would sustain 5 – 5.5 gpm at the set depth (though the ½ hp pump would produce eight gpm without back pressure).

Pumping began at 10:05 a.m. on Thursday December 17 and continued for 72 hours until the pump was turned off at 10:05 a.m. on Sunday December 20. The average flow rate for the test was five gpm. The rate was variable in the early part of the test, due to valve adjustments. A rate of about 5.05 gpm was established as soon as possible, though the rate continually declined with drawdown (due to pumping against a greater head) to 4.95 gpm at the end of the test. An average rate of five gpm was estimated for the test, though the slightly varying flow rate (0.1 gpm decrease during the test) is included for analysis. Recovery data were recorded until Thursday December 31 at 7:00 pm. Figure 8 shows the the flow rate plotted with time.

Background:.....December 9 to December 17, 1998
 Pumping:.....10:05 December 17 to 10:05 December 20 (72 hours)
 Recovery:.....10:05 December 20 to 19:00 December 31
 Average Q:.....5 gpm
 PW to OW distance.....no OW

Figure 8. Flow rate plotted as a function of time for the Evans County #1 test.

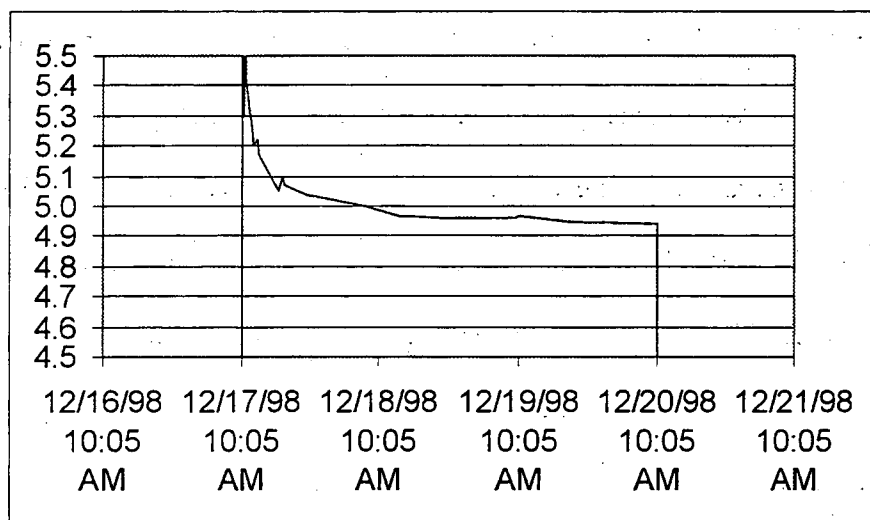

Data Acquisition Methods

Water level readings are recorded as pressure changes in meters of water relative to an initial equilibrium static water level condition. For the duration of a pump test (background through recovery), an In Situ, Inc. "TROLL" transducer was used to measure and record water level changes in the pumping well. Pressure readings were recorded as frequently as every one second at pump on and pump off times to as infrequently as every five minutes when water levels changes are small. A 100 psi "TROLL" transducer / data recorder was positioned one ft above the pump in the

pumping well. Water levels in the 3 other wells at the Evans site were monitored by USGS recorders to determine if pumping the Lower Brunswick would affect zones above and below.

A 1/2 HP submersible pump was installed below 10.5 joints (~220 ft) of 2" pipe, placing it about 120 ft below the initial static water level. Discharge was monitored by a portable Omega inline flow meter. Flow readings were recorded manually and are shown in the Figure 8 above.

Analysis Methods

Trend Effect Corrections

One week of background data and over eleven days of recovery data were collected in the Evans County #1 well. Background data are collected in order to recognize any trends in water level change, such as those caused by extended rainy or dry periods. Water level changes not related to pumping are filtered prior to analysis.

Leakage

Three other wells at the site were monitored during the test to detect water level changes in zones above and below the pumped zone that might result from pumping. Evans County #2 is in the Upper Floridan (below the pumped zone), Evans County #3 is in the Upper Miocene, and Evans Count #4 is in the surficial aquifer.

Well Analysis Methods

Data from the pumping well were used to calculate the transmissivity of the pumped zone and the skin factor of the well (the head loss caused by water being pumped through the screen and altered formation near the well bore). The aquifer storativity was

estimated at 0.0001. Pumping well data analysis is problematic because of three variables (T, S, and skin-factor). If one of the three variables is known or can be estimated, the other two can be calculated. The skin factor of the pumping well can be highly variable depending on well installation. The storativity of the aquifer is less sensitive than either the transmissivity or skin factor, making it the obvious choice to estimate. With an observation well in the same aquifer that is pumped, the aquifer's storativity can be calculated (assumes that water moves much more slowly at the OW and skin effects in the OW are therefore minimal). With no OW, such as the case at Evans County, an intermediate storativity value, 0.0001, within the range observed in confined aquifers, 0.005 – 0.00005, (Freeze and Cherry, 1979) is used as an estimate.

Variable rate curve matching employs the superposition of the Theis solution (1935) or Jacob straight-line method (Cooper and Jacob, 1946) for variable flow rates (as discrete steps), modified for the skin factor analysis of Van Everdingen (1953) for confined aquifers with fully penetrating wells. The skin factor of the observation well is assumed to be zero because of the much lower water velocity away from the pumped well. For partial penetrating wells, data are analyzed using the Hantush (1961, 1964) solution for partial penetrating wells modified to account for the skin factor and multiple flow rate. The screen zone at Evans County is considered to be fully penetrating based on the gamma ray and resistivity logs, Figure 3. Hydraulic conductivity is calculated by dividing the transmissivity by the effective aquifer thickness. Permeability can then be calculated by multiplying the hydraulic conductivity in m/sec by a factor of 104,000 to convert to darcys (at 20° C water temperature; Fetter, 1988).

RESULTS

Water Level Readings

A total of 6528 data points were recorded in the pumping well. During the pumping and recovery periods, values were recorded as frequently as every one second at times of rapidly changing water levels (i.e. at the beginning and end of pumping phase of the test), decreasing to every five minutes when water level changes were relatively small. A maximum drawdown of 31.947 meters (104.8 ft) was observed after 72.0 hours of pumping, Figure 9.

Figure 9 Graph of water level data in the PW, Evans #1, December 9 through December 31. The spikes on 12/9/98 and 12/16/98 are the 30 minute tests to determine optimum flow rate for the three day test. An enlarged version is in Appendix 1A.

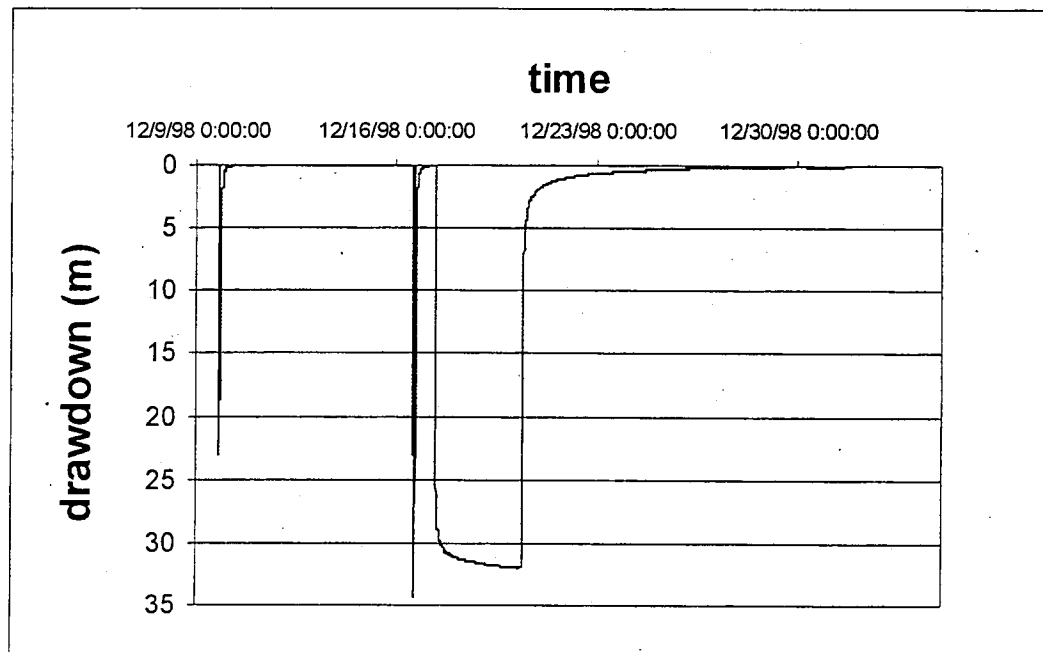

Background water level data was taken for one week prior to the test at Evans County. No trend changes were observed (Figure 10), however, the well never recovered to pre-pumping levels. This could have been the result of a long term decreasing head in the aquifer, though due to the extremely low transmissivity of the aquifer, it is more likely the result of very slow recovery from the 3 days of pumping since no trend was observed in the week prior to the test. There was only a trace of rain during the test.

Figure 10. Time / drawdown curve from Evans County scaled to detect long term trends. There was no trend observed during background data collection. Note the slow well recovery which was recorded for 273 hours.

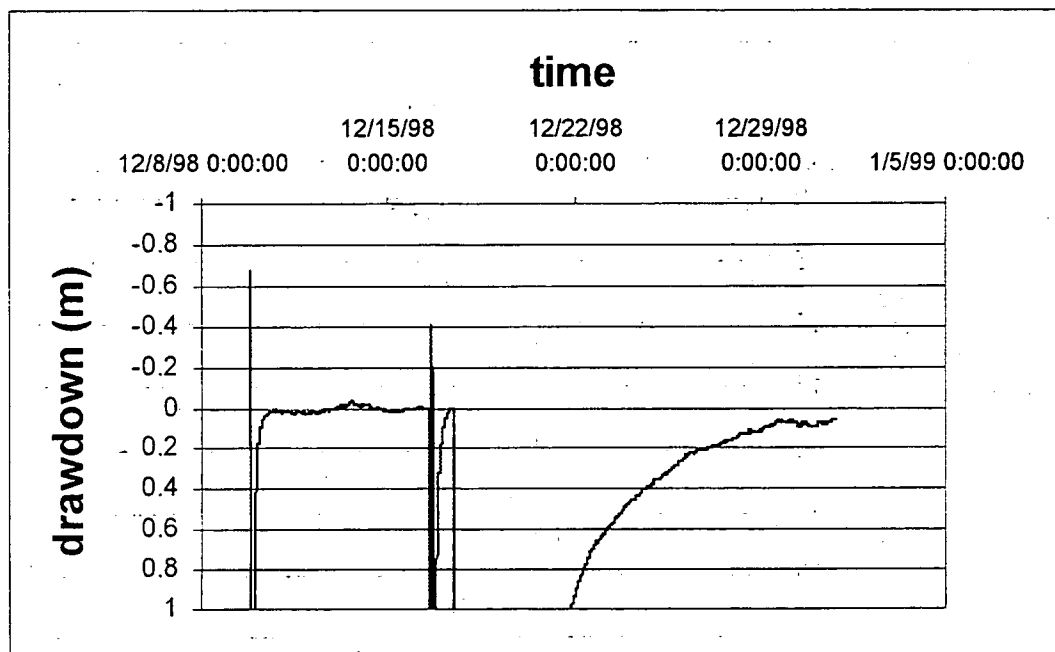

Calculated Aquifer Properties

With no OW data available to calculate storativity, it was estimated at 0.0001. The estimated value only affects the skin factor calculation, not the transmissivity. The drawdown calculated for curve matching was based on several flow rates. A rate of 5.2 gpm was used from pump on (0 seconds) to 8400 seconds (2 hrs and 20 minutes). From 8400 seconds to 86400 seconds (1 day), the flow rate was 5.05 gpm. During day two, the rate was 5.0 gpm and during day three, the rate was 4.95 gpm. Multiple rate steps were necessary to match the actual test data due to the gradual decline in flow rate during the test (caused by the decline of pump capability at progressively greater water depths). The flow rate (Q) is shown in Figure 11, with the scale on the secondary y axis.

Curve matching of pumping and recovery data suggests a transmissivity (T) 25 ft²/day (Figure 11). Based on an aquifer thickness of 60 ft, the hydraulic conductivity is 0.42 ft/day with a corresponding permeability of 0.14 darcys (assuming 20^o C water). The match of pumping data is best from 8400 seconds through the end of the test, after the flow rate change to 5.05 gpm. The low flow rate and large well bore storage, limit the usefulness of the early time data. Note that the curves of calculated and measured data on Figure 11 are difficult to distinguish due to the excellent match.

Figure 11 Theis-Jacob curve match for Evans County #1, T of 25 ft²/day. An enlarged version is in Appendix 1b.

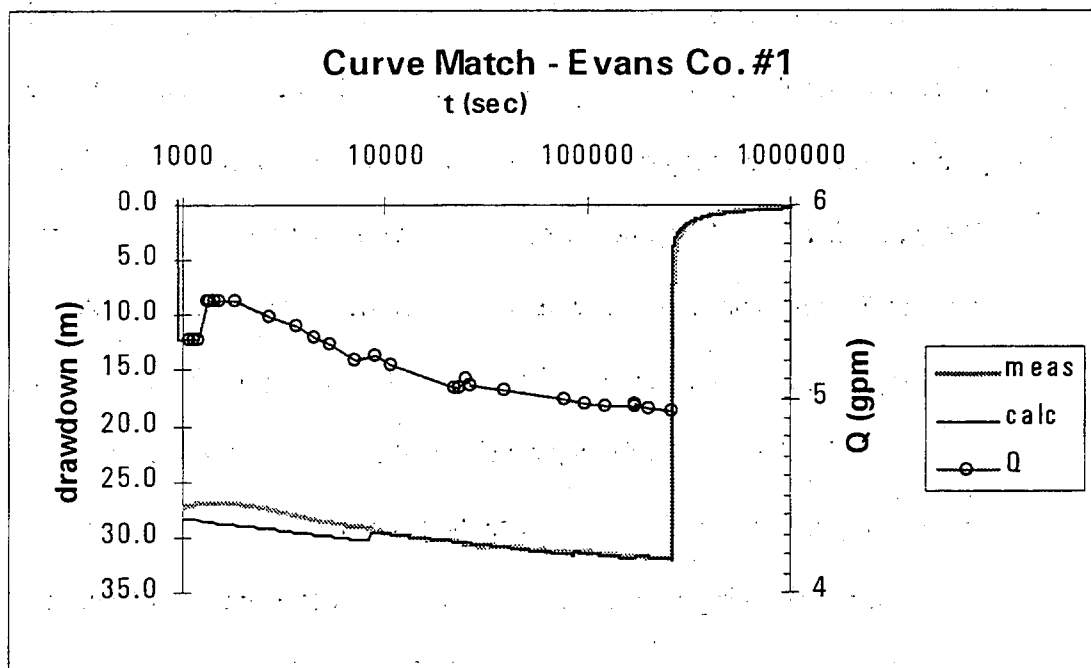

Specific Capacity

An average flow rate of five gpm created a 105 ft drawdown after 72 hours of pumping. This equates to a specific capacity of 0.05 gpm/ft.

Leakage

Considering the low flow rate of five gpm and the and the relative screen zones of the wells at Evans County (Figure 12), detectable leakage was not expected. Water level data for Evans County # 3 (screened in the Upper Miocene) and #4 (water table) were provided by the USGS and are shown in Figures 13 and 14. The sharp rise in water level of about 0.1 ft in well #3 and 0.2 ft in well #4 on December 28, is the result of a slight movement of the water level recording device as data are downloaded. The slight water level rise in the surficial well (#4) during pumping is probably the result of mounding from the discharge water.

Figure 12. Schematic section of the Evans County well cluster. Gamma ray and resistivity logs are superimposed on Evans County #2. Screen zones are indicated for wells #1, 3, and 4. Stratigraphic units from Clarke, 1999.

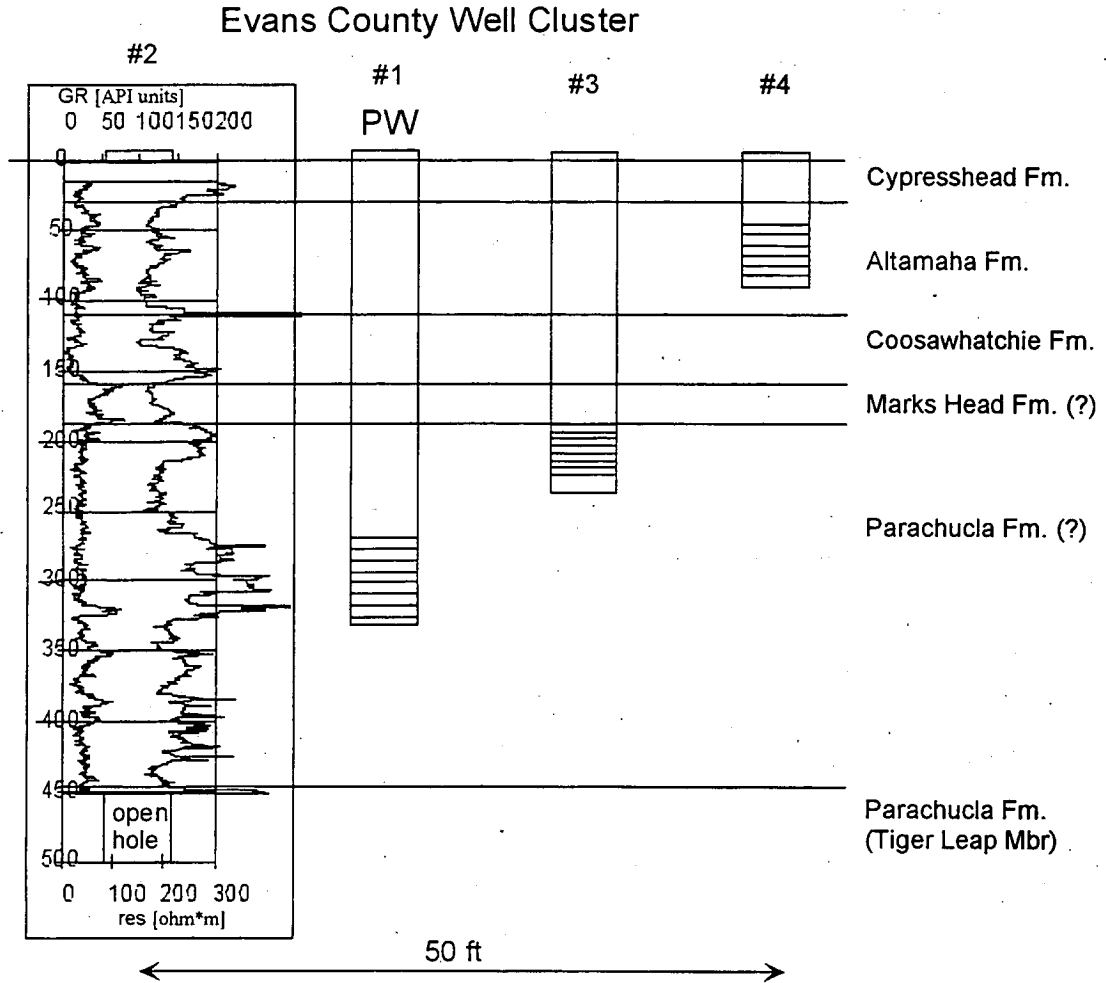

Figure 13. Water depth vs time for Evans County #3.

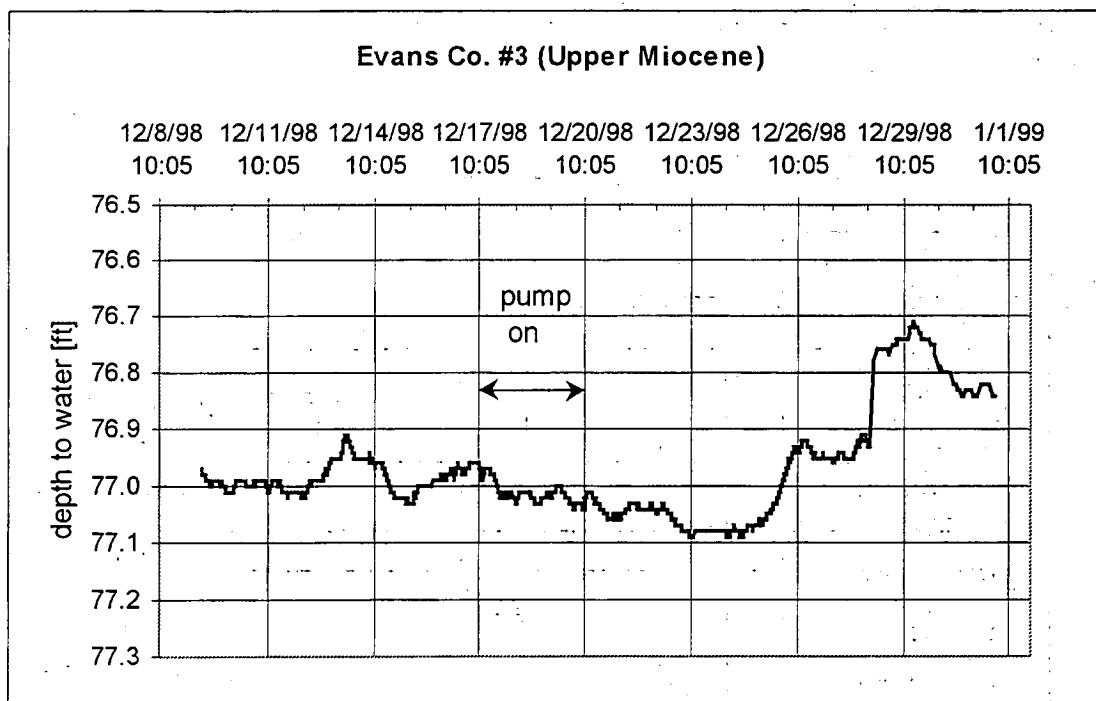
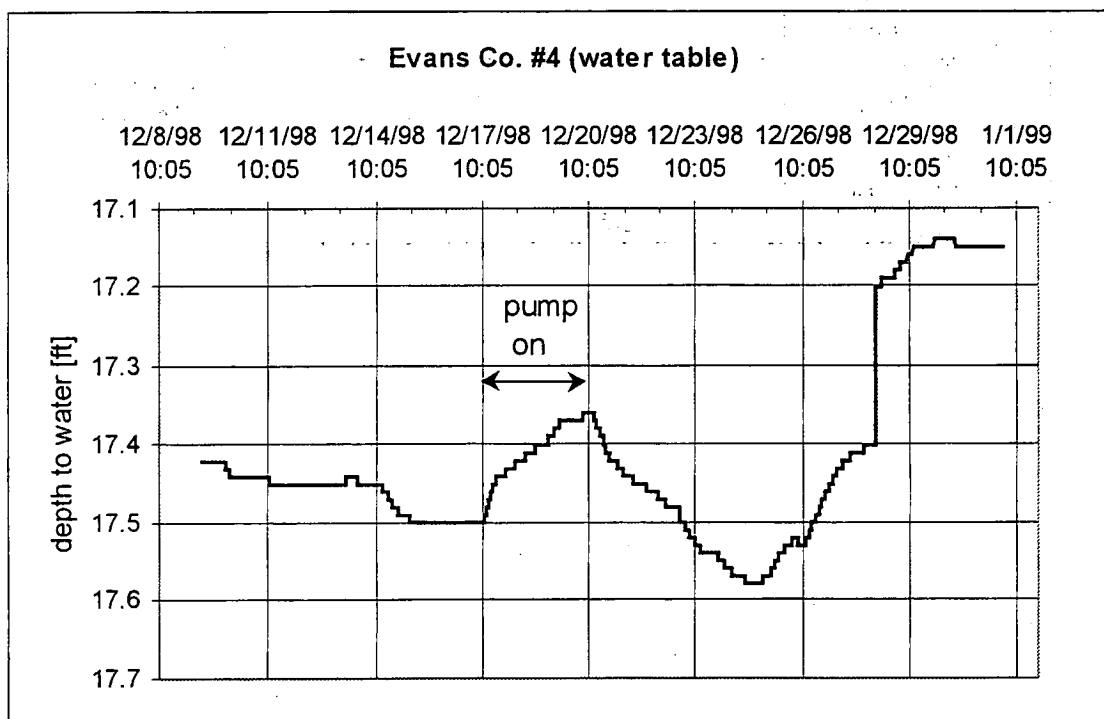

Figure 14. Water depth vs time for Evans County #4.



DISCUSSION

Test Logistics

A low flow rate of five gpm created a drawdown of 105 ft in the Lower Brunswick aquifer. The large drawdown caused the flow to vary slightly over the test due to pump capacity.

Analysis

The analysis yielded a transmissivity value of 25 ft²/day. The storativity of 0.0001 was estimated based on intermediate values for confined aquifers of the type tested. There was no observation well screened in the pumped zone. Based on an aquifer thickness of 60 ft, a hydraulic conductivity of 0.42 ft/day and permeability of 0.14 darcys were calculated. These are not promising results for even small usage demands. Relative to the previous sites (Table 1), the hydraulic conductivity at the Evans site is very low. However, the zone may be locally variable. Conversations with a local farmer, indicated that a well ~3 miles to the north produces in excess of 100 gpm from about 230 ft. This information was not confirmed.

Table 1 Summary of test results for Tybee Island, St. Marys, Toombs County, and Evans County.

<u>Site</u>	<u>Aquifer</u>	<u>T (ft²/day)</u>	<u>K (ft/day)</u>	<u>Q[gpm]</u>	<u>s [ft]</u>	<u>SC [gpm/ft]</u>
Tybee Island	Floridan	21,000	4300	100	32	3.13
St. Marys	Miocene	500	13.5	71	55	1.30
Toombs	Miocene	400	6.5	35	47	0.75
Evans	Miocene	25	0.42	5	105	0.05

APPENDIX 1A. Enlarged Figure 9. Graph of water level data in the PW, Evans #1, December 9 through December 31. The spikes on 12/9/98 and 12/16/98 are the 30 minute tests to determine optimum flow rate for the 3 day test.

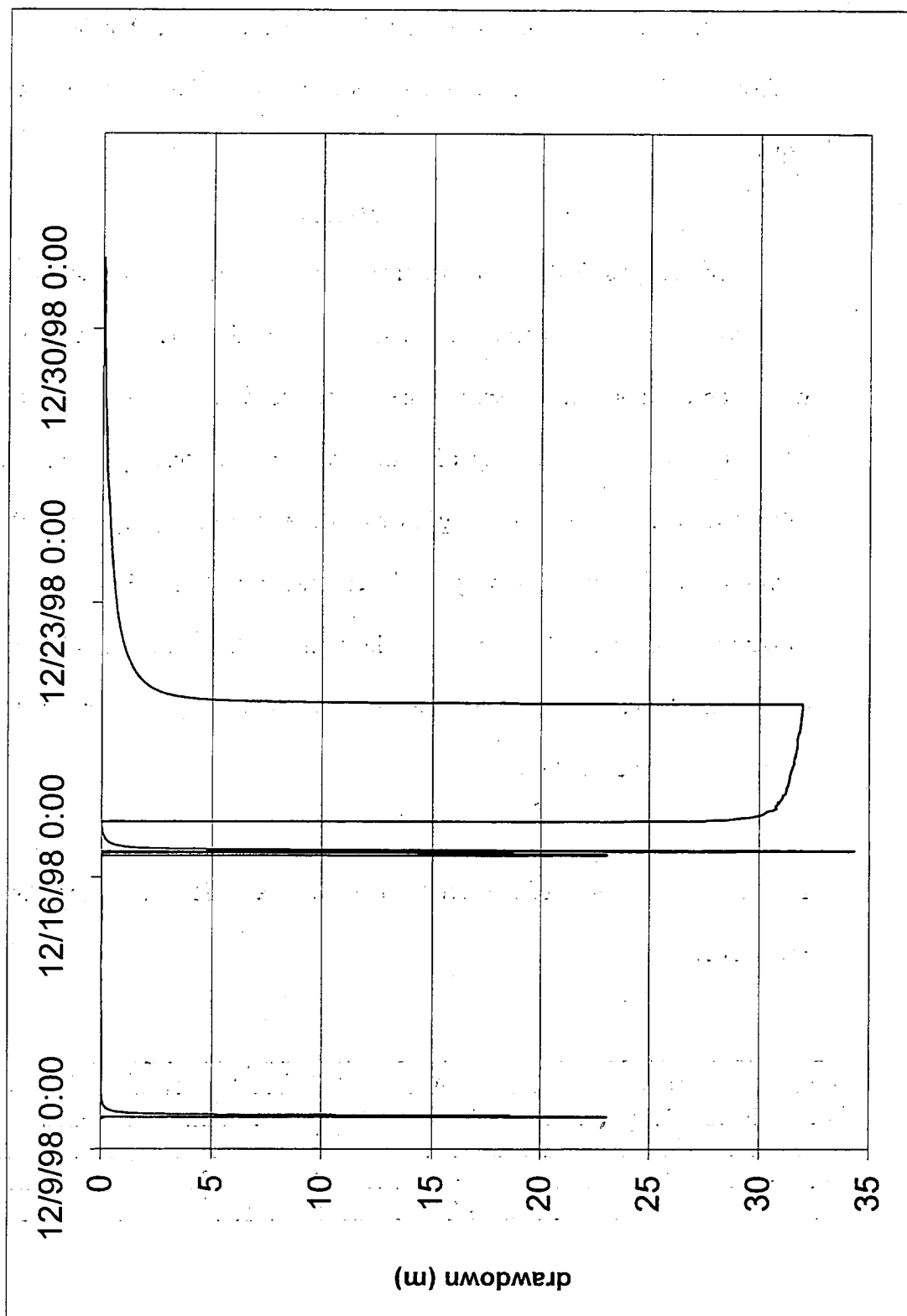

APPENDIX 1B. Enlarged Figure 11. Theis-Jacob curve match for Evans County #1, T of 25 ft²/day.

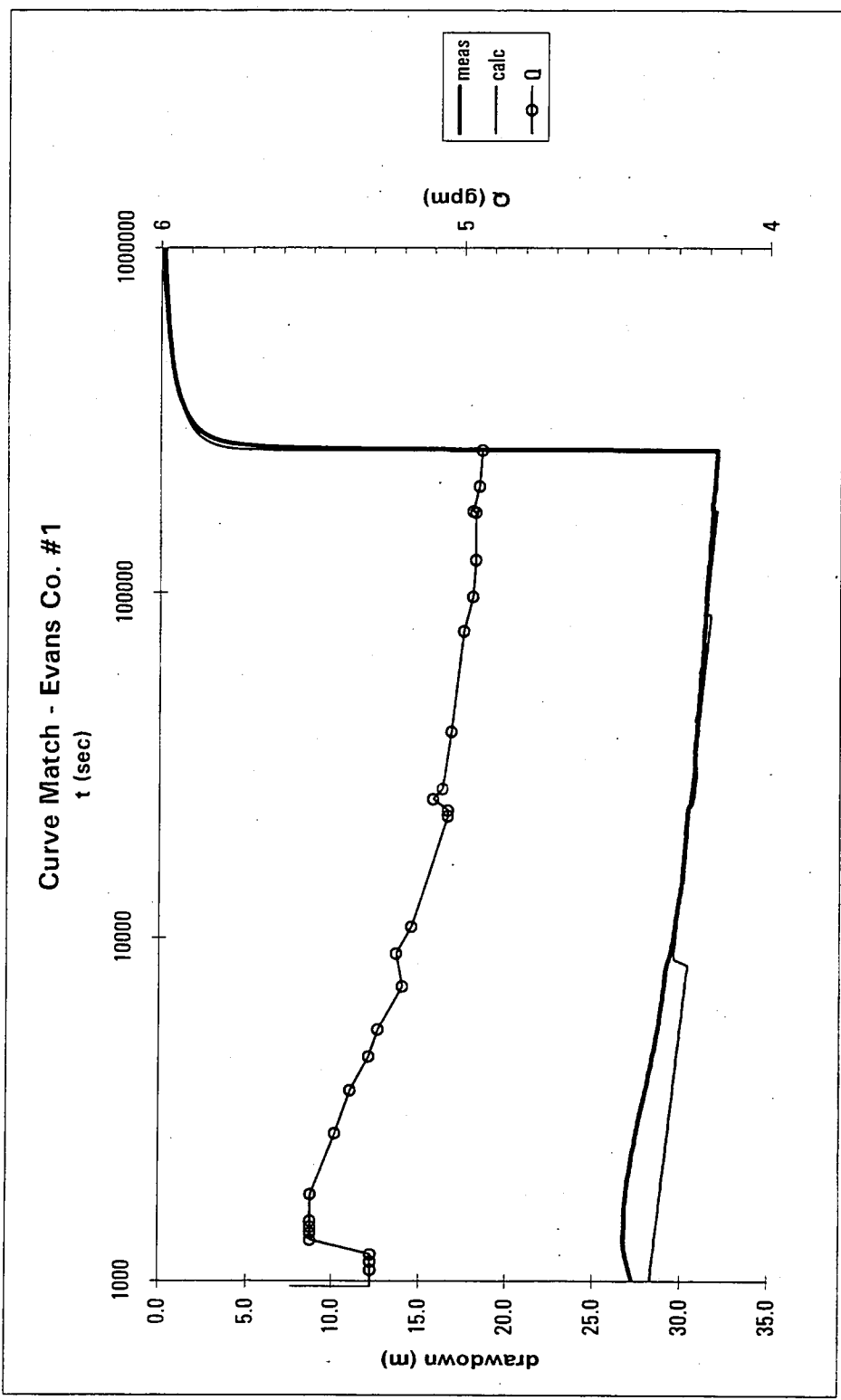

REFERENCES

- Clarke, John S., 1999, personal communication, USGS supervisory hydrologist, Atlanta, Georgia.
- Cooper, H. H., and Jacob, C. E., 1946, A generalized graphical method for evaluating formation constants and summarizing well field history, Transactions of the American Geophysical Union, v. 27., pp. 526-534.
- Earlougher, Robert C., 1977, Advances in Well Test Analysis, Millet the Printer, Inc., Dallas, Texas, 264 p.
- Fetter, C. W., 1988, Applied Hydrogeology, Macmillan, Inc., New York, NY, 691 p.
- Freeze, Allan R., Cherry, John A., 1979, Groundwater, Prentice-Hall, Inc., Englewood Cliffs, NJ, 604 p.
- Hantush, M. S., 1961, Drawdown around a partially penetrating well, Journal of the Hydraulics Division, Proceedings of the American Society of Civil Engineers, pp. 83-98.
- Hantush, M. S., 1964, Hydraulics of wells: Advances in hydrosociences, v.1., Academic Press, New York, pp. 281-432.
- Jacob, C. E., 1940, On the flow of water in an elastic artesian aquifer, American Geophysical Union Transactions, part 2, pp. 574-586.
- Theis, C.V., 1935. The relation between lowering of the piezometric surface and the rate and duration of the discharge of a well using groundwater storage. Transactions of the American Geophysical Union, Vol. 2., pp. 519-524.
- Van Everdingen, A. F., 1953. The skin effect and its influence on the productive capacity of a well. Petroleum Transactions, Vol. 198, pp. 171-176.

Cost: \$160
Quantity: 250

The Department of Natural Resources (DNR) is an equal opportunity employer and offers all persons the opportunity to compete and participate in each area of DNR employment regardless of race, color, religion, national origin, age, handicap, or other non-merit factors.